

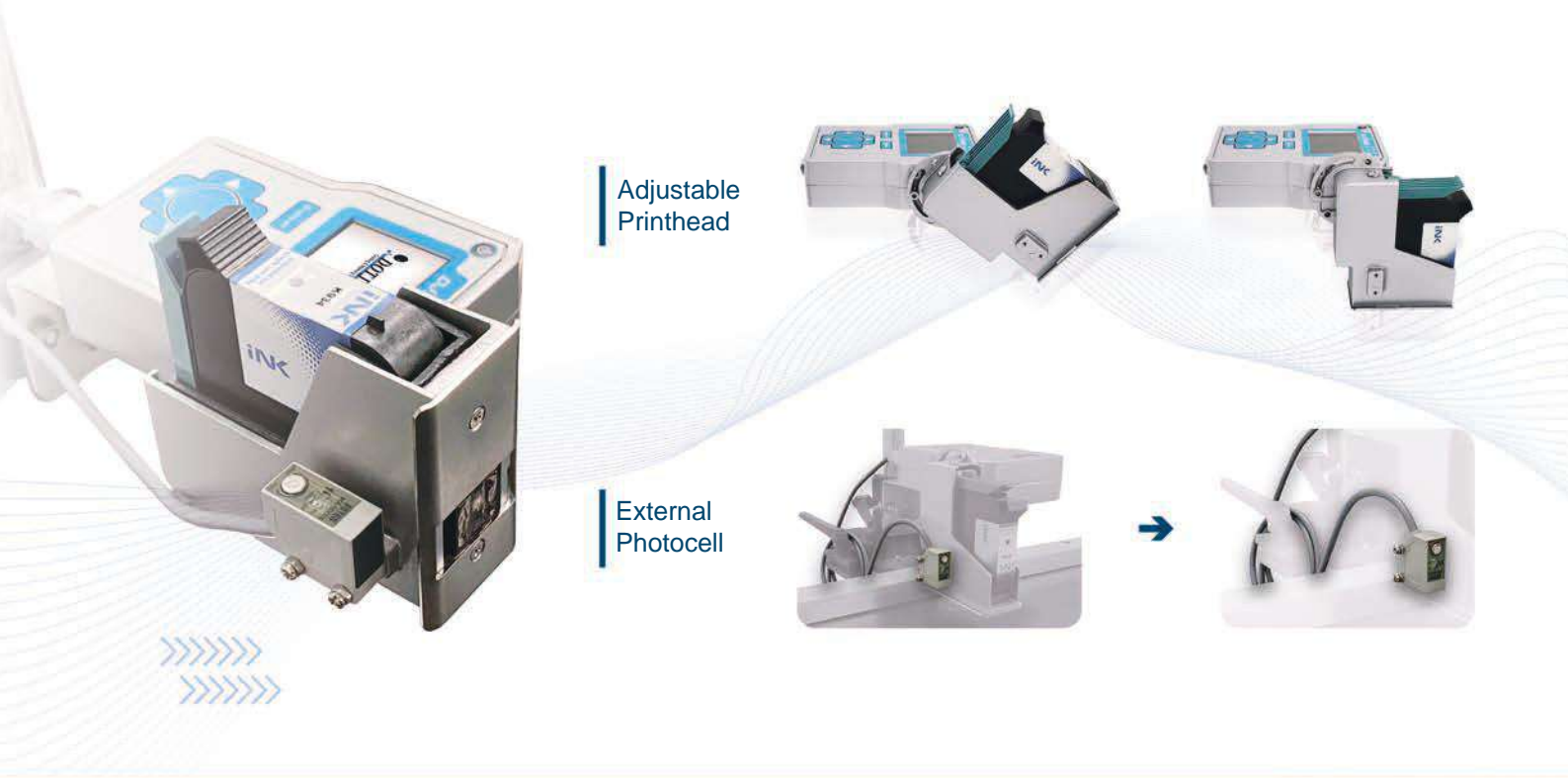

**Compact, robust and low-cost design
but still performs high print efficiency.**

■ Diverse Installation

- ✓ A compact unit TIJ printer with an angle-adjustable printhead and external photocell.
- ✓ Suitable for diverse installation demands.
- ✓ Be integrated with labeling machine and capping machine.



■ Print Efficiency

A cost-saving DJ1 brings you excellent print efficiency.

DJ1 has less components but keeps excellent inkjet printing technology to achieve users' production efficiency.

- Max 20 units of print per second.(Depend on print message length)
- High print speed:
Aqueous ink: max 60 meters/min
Solvent ink: max 75 meters/min

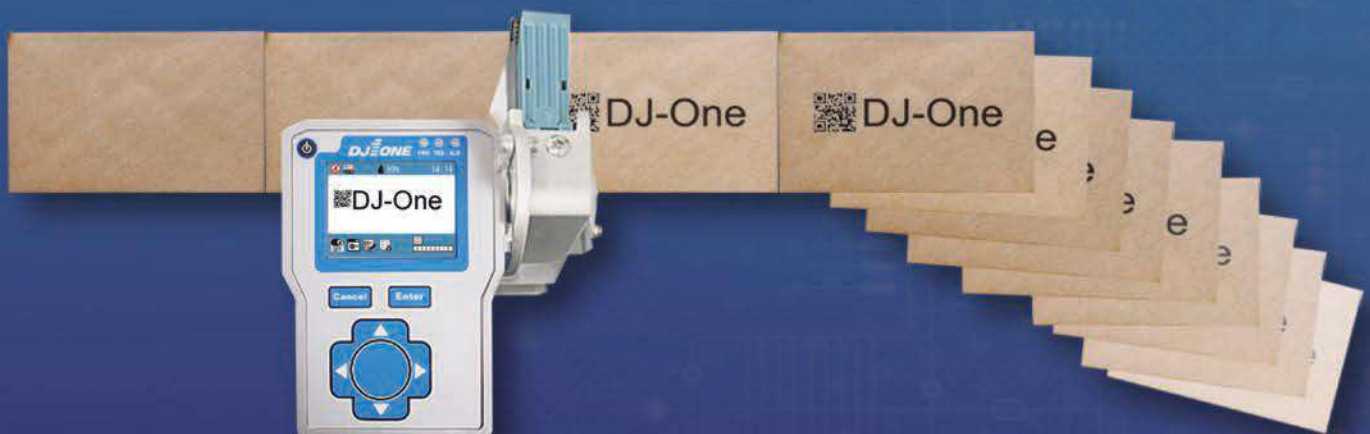

Print Message Content

Text, image, date, time, lot/batch number, shift code and static barcode objects. Other languages input by text builder.

Message lines from 1 line to 4 lines.

Print height: Max 4 options based on the number of message line.

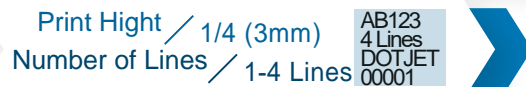
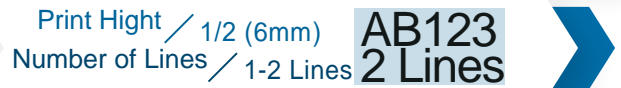
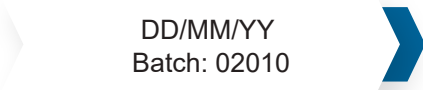

Max. print length: When print height is 12.7mm, the max print length is 127 characters plus appendant 3 sets of printing messages, total 508 characters.



Manage Print Jobs With Less Cost

- 1 Create printing messages by easy-to-learn PC software or by Android smartphone.
- 2 Max storage is 30 print jobs per file, only required printing messages can stay in DJ1 printer.
- 3 Give a short description each print job to help users find the correct print job easily.
- 4 Transfer the data to DJ1 by a USB driver.



Less Function but Protect Correctness

A routine to help users avoid mistakes: To download required printing messages from a USB stick instead of giving the function to edit content by onsite DJ1. All an operator needs to do is to press the controller buttons to select print job and start printing.

Easy to Learn Software

- ✔ User-friendly interface design for PC software and Android App.
- ✔ Easy to build print messages with a clear preview section.
- ✔ Ink consumption calculation per print message.
- ✔ Append message function gives a capability to combine messages into 1 print job.
- ✔ Transfer the data to the printer by a USB stick.

“
**Take
 1 minute**
 To learn how to use
 DJ1 PC software

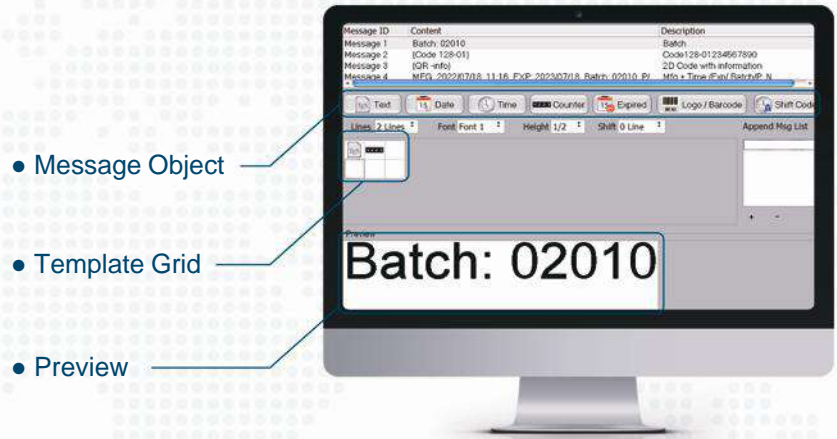

Text builder function in logo list allows multiple languages input with various fonts.

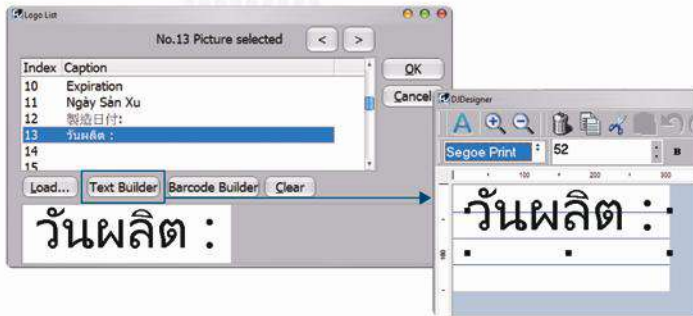

Simply click and drag required message object into template grid, then start editing content.



“ Android App ”



To build print message by an Android smartphone gives the user flexibility to edit the content onsite. Transfer the data to the printer by a USB stick.



■ Controller Operation

- ✓ 2.8" TFT LCD display.
- ✓ 6 simple buttons to operate.
- ✓ Multiple languages for the operation interface.
- ✓ Low ink LED indicator to build on the controller membrane.
- ✓ Few steps to adjust parameters and start printing.



• LED light indicators :
Power, Trigger, Alarm

• Printing status display.

• Simple route to select
printing job
and adjust parameters.

• 6 buttons to operate the controller.



Print Setup

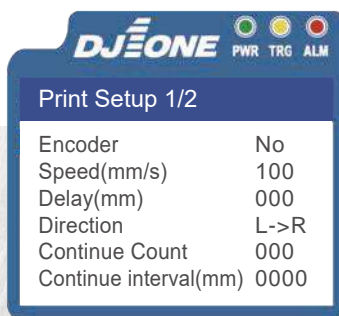

Select Message



Function List

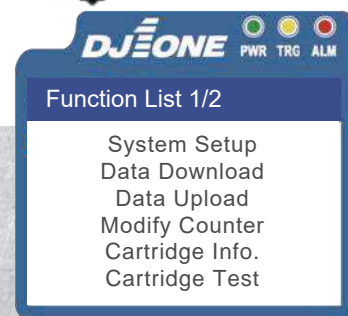

• Select Message

The short description of each message is given by user when user creates message by PC or Android App.

Coding and marking work can be simple when you work with DJ1.

1 Create Print Message (Max 30 print jobs.)



2 Save required message file to a USB stick.



3 Operate DJ1 printer



4 Print job is selected.



5 Install / replace ink cartridge.



6 Plug the USB stick onto DJ1.



7 Press the buttons to move the cursor and to enter the required section.



8 Download message file from USB stick to DJ1 printer.



• There is no need to re-download the same file next time to use DJ1 until the user wants to change file.



• Select a required message.



• Select "Start / Stop Printing."

• Print message content displays on the screen.



■ Ink Cartridge

HP TIJ 2.5 technology
A clean cartridge system ensures the best cartridge lifetime and keeps uptime.



- **Hot-swapping cartridge**
Effortless to replace ink cartridge without downtime.
- **Printing resolution**
300 dpi x 300 dpi
- **Print speed can be up to**
60 m/ min (aqueous-based ink) and
75 m/ min (solvent-based ink)
- **Ink types**
aqueous ink, solvent ink and UV-curable ink
for different substrates.

■ Smart Card

The printer reads and downloads the parameters from the smart card automatically.



- A smart card on cartridge stores the cartridge print parameters information.
- Automatic ink identification allows parameters setting for each ink cartridge to achieve the best performance.

■ Bulk Ink Supply

- Bulk ink supply system is optional to help users reduce the number of time to change over ink cartridge.
- Aqueous-based ink, 370ml

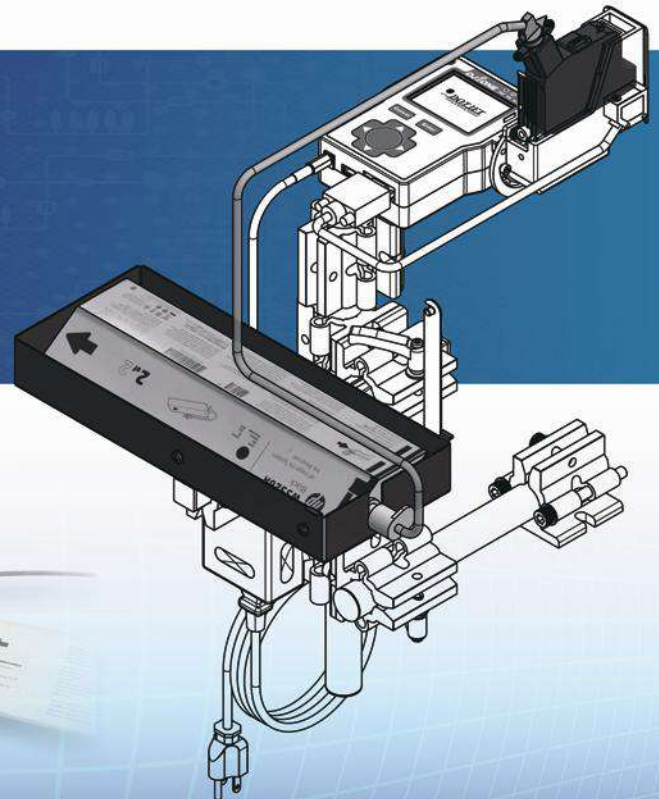

SPECIFICATIONS

Model	DJ1
Technology	hp TIJ2.5
Housing	Aluminum casting
Display	2.8" TFT LCD display.
Power requirement	AC 110-220v
Operation temperature	5°C to 45°C (41°F to 113°F)
Message Storage	30 print jobs
Print line	1~4 lines
Print height	Max 4 options to select from depends on the number of print line: 12.7mm, 6mm, 3mm, 1.5mm.
Print speed	Max: 60m/min- Aqueous ink cartridge. Max: 75m/min- Solvent ink cartridge.
Max print length	508 characters
Print resolution	300 dpi x 300 dpi
Max Ink throw distance	6mm is recommended.
LED indicators	Power, Trigger, Alarm (ink low)
Software function	Any of languages text, lot and box number, date- time code, shift code, logo
Print font	Two available fonts for printing: standard, bold
Printer operation language	Multiple languages available. (Some languages' translation support may be required.)
PC software language	Multiple languages available. (Some languages' translation support may be required.)
Android app language	English
Dimension	(L/W/H) 202 x 143 x 120 mm
Weight	652g (excluding cartridge)
Optional	Encoder, Bulk ink supply (aqueous ink)

